

20  
23

Guidelines for inspection and servicing  
**Drawbars and drawbar eyes**



# General information

## General

The components used to connect a vehicle and trailer are exposed, even during normal use, to very high tensions. Regular service and maintenance is a prerequisite if the drawbar is to function well for the duration of its service life.

The length of the service intervals depend on the type of trailers, the loads, roads and climatic conditions etc. The service should ideally be carried out in conjunction with other inspection of the vehicle, e.g. every 60,000 or 90,000 km.

***If daily inspection or safety checks show that the function of the product has been impaired, servicing must be carried out immediately.***

***If any of the product's wear limits have been exceeded, this is an indication that other parts also require servicing.***

Check that all type plates and warning/information labels are legible and have not been painted over, washed off or otherwise damaged. Illegible labels must be replaced and can be ordered from VBG Truck Equipment.

If the drawbar/drawbar eye is damaged due to e.g. jackknifing, off-road driving, reversing or collision, the drawbar/drawbar eye must be replaced.

NB! All equipment must be depressurised and without voltage before servicing is carried out. This means that you must disconnect the supply air and the power to drawbars.

Always follow the VBGs instructions and the vehicle manufacturer's bodybuilding instructions.

---

## Guidelines for inspection and servicing Drawbars and drawbar eyes 2023

© VBG GROUP TRUCK EQUIPMENT AB

Version d, 12/04/2023

The contents in this publication may not be reproduced either in full, or in part, without the prior approval of VBG GROUP TRUCK EQUIPMENT AB.

This prohibition is applicable for all forms of reproductions in all types of media, including electronic media.

## Explanation of symbols



① ② ③

### Severity

3 = STOP to ensure future use.

2 = Rectify as soon as possible, within four weeks.

1 = Rectify when able or during next service. Within no more than one year.



### Warning!

Never put your fingers into the coupling mouth as they may be crushed. An open coupling always involves a risk of crushing due to the powerful springs that constitute the coupling's closing function.

Size	Quality	Torque (Nm)	
		Flange	Washer
M14	8.8	140	125
M14	10.9	163	
M16	8.8	210	195
M16	10.9	250	290



Prescribed tightening torques apply to bolt kits supplied by VBG Group Truck Equipment AB.

# Contents

General information on drawbars and drawbar eyes .....	4
Multi and Multi XF, Optimal .....	12
Optimal, Automatic and Universal drawbar .....	14
Automatic drawbar 26-080000 and 26-100000.....	16
General information on drawbar eyes.....	20
Screwed flange eyes 50/57.....	24
Drawbar eyes 40/50/57/Nato76 fitted with castellated nuts/Clamped drawbar eye.....	26

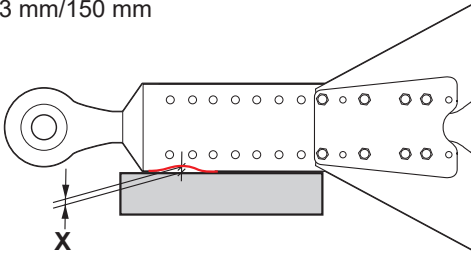

## General information on drawbars and drawbar eyes

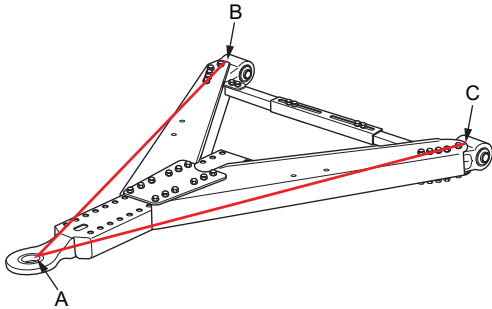
Checkpoint	Symptom	Fault
<p>Drawbar eye attachment.                      Legs.                      Front slider.                      Rear member/cross member.                      Hinged bracket.                      Catwalk.                      Drawbar balance spring attachment.</p>		
<p>Legs, front and rear sliders, cross member, hinged brackets.</p>	<p>Deformations.                      The trailer does not “track” the vehicle.                      Marks from straightening work such as in very heat-affected zones.                      Welds</p>	<p>Dents, kinks, twists and bent sheet metal parts such as side members, front and rear sliders, cross member, etc.</p>
<p>Legs, front and rear sliders, cross member, hinged brackets.</p>	<p>Deformations.                      Cracked, flaking paint.                      Thin streaks where dust and dirt are not present.                      Streaks that are rust-coloured.                      Visible cracks, any rust marks around the crack.</p>	<p>Cracks.</p>
<p>Complete drawbar.</p>	<p>Be aware of noise when driving and if the trailer veers sideways.</p>	<p>Geometric error in the A-shape.</p>

Inspection method	Requirements, wear limits, etc.	 <b>Instructions for rectification</b>
<p>Attachment, damage, wear, play.</p> <ul style="list-style-type: none"> <li>– Visual check of attachment, damage and wear. The term attachment also covers the eye attachment in the drawbar and the wear ring's attachment in the drawbar eye.</li> <li>– Rust damage check using tools is performed when corrosion is found.</li> <li>– Play check of drawbar bearing and extension mechanism. This check is done by applying the trailer brake and rocking the traction vehicle.</li> <li>– Jackknifing damage/repairs/welds.</li> <li>– Wear, eyes/bushings.</li> </ul>		<p>①②③</p>
<p>Check that none of the parts are deformed. Deformation may arise in connection with jackknifing, reversing or other external influences.</p>	<p>Generally, no deformations are permitted. Deviation from theoretical surface/shape greater than the specified dimensions is considered to be a deformation. No welding or warping is permitted.</p> <p>Deviation/length  5 mm/1,000 mm  3 mm/150 mm</p> 	<p>②</p> <p>In the event of deformation, warping or welds, visit the workshop and replace the damaged parts. When the components have been dismantled, they must be re-tightened after driving 2,500 km.</p>
<p>Check that none of the parts are cracked. The greatest risk of cracking is close to bend radii, welds and hole edges.</p> 	<p>No cracks are permitted.  No welding or other repairs are permitted</p>	<p>③</p> <p>In the event of cracking, stop driving and immediately visit a workshop, replace damaged parts. After replacing damaged parts, tightening takes place after driving 2,500 km.</p>
<p>Cross-measure between the centre of the eye and each rear bracket.</p>	<p>Dimensions: <math>ab = ac \pm 2 \text{ mm}</math>.</p> 	<p>①</p> <p>Replace any defective materials and adjust. After any replacement of damaged parts and adjustment of the geometry, retightening must be performed after driving 2,500 km. Use the installation instructions for any adjustment.</p>

**General information on drawbars and drawbar eyes**

<b>Checkpoint</b>	<b>Symptom</b>	<b>Fault</b>
<p>Bolted joint.</p>	<p>Scuff marks around bolted joints. Rust around bolt heads/nuts. Squeaking/clicking sound.</p> 	<p>Loose or missing bolts.</p>
<p>Legs, rear member, cross member.</p>	<p>The surface treatment is flaking/chipped. Rusty water flows out from cavities/ partially closed cavities. Loose rust flakes/"soft" material/porosity in the base metal.</p>	<p>Corrosion. "Pitting".</p>
<p>Complete drawbar.</p>	<p>The surface treatment is flaking/chipped. Rusty water flows out from cavities/ partially closed cavities.</p>	<p>Corrosion. Surface rust.</p>
<p>Hinged bracket, type Vibra Block.</p>	<p>Meandering trailer, high degree of longitudinal movement, loose rubber residue outside of the Vibra Block, noise.</p>	<p>Significant movement in the hinged brackets, type Vibra Block, due to worn rubber.</p>

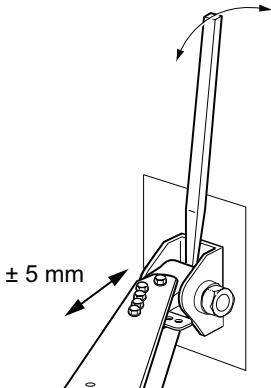
Inspection method	Requirements, wear limits, etc.	 <b>Instructions for rectification</b> ①②③
<p>Be aware of banging/clicking sounds or jolts when driving with a trailer. Check whether rust has formed around the bolt heads and around holes where any bolts have been. Check to see if there has been any movement in the bolted joints. Check whether any rotation occurs during test-tightening to the prescribed tightening torque in accordance with the table on page 2.</p>	<p>No movement is permitted in the bolted joint and there should be no rotation during test-tightening to the prescribed tightening torque.</p> <p>Prescribed tightening torques apply to bolt kits supplied by VBG Group Truck Equipment AB.</p>	<p>③ In the event of movement in the bolted joint, stop driving and visit a workshop immediately. Dismantle/check constituent parts and replace any that are damaged.</p> <p>② If there is too low a tightening torque, visit a workshop. Dismantle/check constituent parts and replace any that are damaged. When the components have been dismantled, they must be re-tightened after driving 2,500 km.</p> <p>Examples of damage.</p> <ul style="list-style-type: none"> <li>- Deformed holes</li> <li>- Damaged threads</li> <li>- Scuff marks on bolts</li> <li>- Fretting damage</li> </ul>
<p>Check regularly that there is no corrosion damage such as "pitting". Take particular note of cavities and partially enclosed areas etc.</p>  <p>Side member that has rusted through</p>	<p>"Pitting" should not occur; particular attention should be paid to the inside of cavities and partially enclosed areas.</p>	<p>③ In the event of pitting, stop driving and immediately visit a workshop. In the event of pitting, damaged parts must be replaced. Welding is not permitted.</p>
<p>Take particular note of cavities and partially enclosed areas, etc.</p>	<p>Surface rust or red rust must be dealt with urgently.</p>	<p>① Remove external rust using a blast-cleaner or a steel brush, and then reapply corrosion protection.</p>
<p>Be aware of noise or jolts when driving with a trailer. Check using a crowbar that there is no play/movement exceeding <math>\pm 5</math> mm in the hinged brackets. It is also possible to apply the trailer brake while pulling slightly with the vehicle to assess whether the movement is the same on both the right and left sides.</p>	<p>No obvious play/movement exceeding <math>\pm 5</math> mm may occur and the movement must be equal on the right and left sides.</p>	<p>② If the movement exceeds <math>\pm 5</math> mm, visit a workshop, replace damaged parts.</p> 

## General information on drawbars and drawbar eyes

Checkpoint	Symptom	Fault
<p>Hinged bracket, type Vibra Block.</p>	<p>Meandering trailer, significant movement longitudinally, noise.</p>	<p>Significant movement in the hinged brackets, type Vibra Block, due to play between the hinged bracket's centre housing and the hinged bracket's ears at the front of the trailer.</p>
<p>Hinged bracket, type Vibra Block.</p>	<p>Meandering trailer, high degree of longitudinal movement, sometimes with a rattling sound when the pivot bolt hits against the ears' hole edges.</p>	<p>Significant movement in the hinged brackets, type Vibra Block, due to loose or broken pivot bolt; the pivot bolt slides radially.</p>



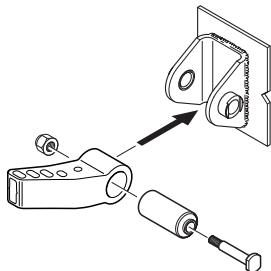
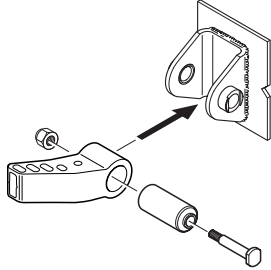



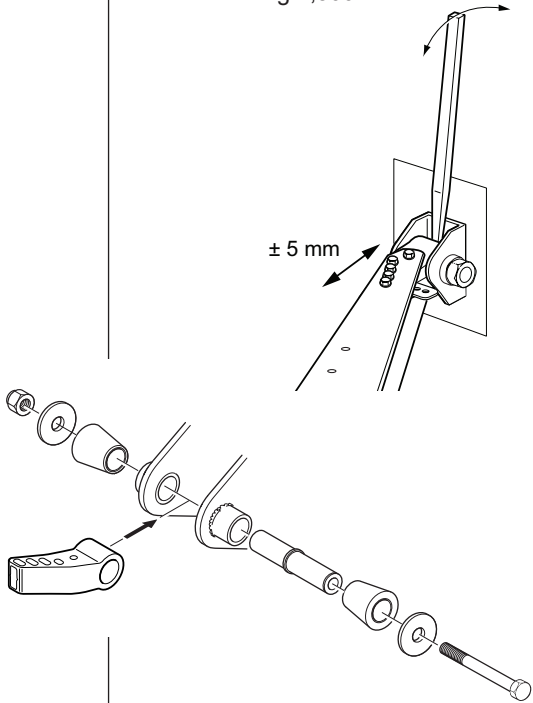

Inspection method	Requirements, wear limits, etc.	 <b>Instructions for rectification</b>
<p>Be aware of noise or jerks when driving with a trailer. Check whether there is rust on the contact surfaces around the head of the pivot bolt or the nuts and/or scuff marks between the centre housing and the rear bracket's ears.</p> <p>Check using a crowbar that there is no play/movement between the centre housing and the ears of the rear bracket. It is also possible to apply the trailer brake while pulling slightly with the cab to assess the play/movement between the pivot bolt/nut and the rear bracket ears on both the right and left sides.</p> <p>Check the tightening torque, 650 Nm.</p>	<p>No play or movement is permitted.</p>	<p>① ② ③</p> <p>③ In the event of movement/ play between the centre housing and the ears of the hinged bracket, stop driving and immediately visit a workshop to replace damaged parts. When the components have been dismantled, they must be re-tightened after driving 2,500 km. Tightening torques 600-650 Nm.</p> <p>Examples of damage.</p> <ul style="list-style-type: none"> <li>- Deformed holes</li> <li>- Damaged threads</li> <li>- Scuff marks on the pivot bolt</li> <li>- Fretting damage</li> </ul> 
<p>See if there is rust on the contact surfaces around the head of the pivot bolt or nuts.</p> <p>Check for scuff marks between the pivot bolt and the ears of the rear bracket.</p> <p>Check using a crowbar that there is no play in the rear brackets.</p> <p>It is also possible to apply the trailer brake while pulling slightly with the cab to assess the play/movement between the pivot bolt/nut and the hinged bracket ears on both the right and left sides.</p>	<p>No gap or movement is allowed.</p>	<p>③ In the event of movement/ play between the pivot bolt and the ears of the hinged bracket, stop driving and immediately visit a workshop to replace damaged parts. When the components have been dismantled, they must be re-tightened after driving 2,500 km. Tightening torques 600-650 Nm.</p> <p>Examples of damage.</p> <ul style="list-style-type: none"> <li>- Deformed holes</li> <li>- Damaged threads</li> <li>- Scuff marks on the pivot bolt</li> <li>- Fretting damage</li> </ul> 

## General information on drawbars and drawbar eyes

Checkpoint	Symptom	Fault
Hinged bracket, type Briab.	Meandering trailer, significant movement longitudinally, loose rubber residue around the hinged bracket's ears.	Significant movement in the hinged brackets, type Briab, due to worn rubber.
Hinged bracket, type Briab.	The scuff marks between the pivot bolts and their washers.	The pivot bolt's head/nut slides radially towards the washer because it is loose or damaged.

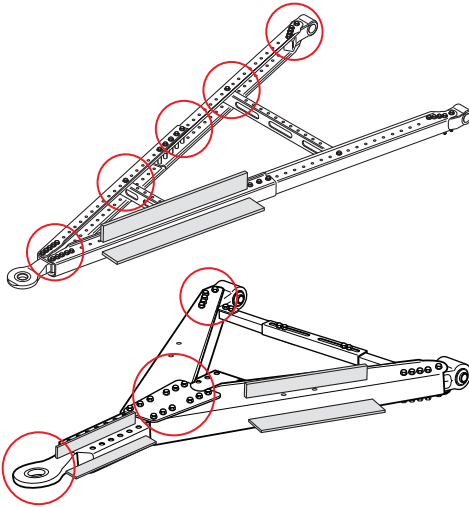
Inspection method	Requirements, wear limits, etc.	 <b>Instructions for rectification</b> ①②③
<p>Be aware of noise or jerks when driving with a trailer. Check, with the aid of a crowbar, that there is no play in the hinged brackets.</p> <p>It is also possible to apply the trailer brake while pulling slightly with the vehicle to assess whether the play and movement are the same on both the right and left sides.</p>	<p>There should be no obvious play.</p>	<p>② In the event of play, visit a workshop to replace damaged parts. When the components have been dismantled, they must be re-tightened after driving 2,500 km.</p> 
<p>See if there is rust on the contact surfaces around the head of the pivot bolt or nuts. Check using a crowbar that there is no play in the hinged brackets. It is also possible to apply the trailer brake while pulling slightly with the vehicle to assess whether the play and movement are the same on both the right and left sides.</p>	<p>No movement is permitted.</p>	<p>③ In the event of movement/ play between the pivot bolt and the washers, stop driving and immediately visit a workshop to replace damaged parts. If there is any visible damage, these parts must be replaced. When the parts have been dismantled, they must be re-tightened after driving 2,500 km.</p>

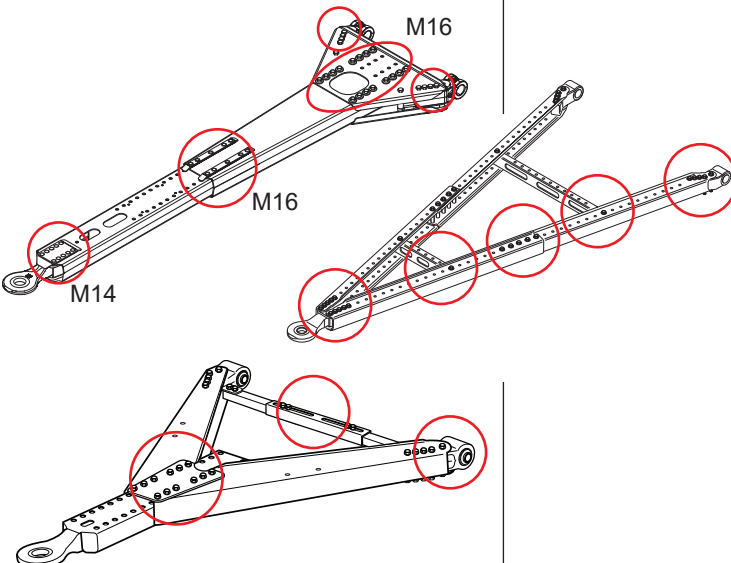
Checkpoint	Symptom	Fault
<p>Legs and cross members.</p>	<p>Paint chipped/cracked or deformed sections.</p>	<p>Reduced durability due to the drawbar eye, side member, front slider or other part being deformed/curved/dented/kinked or having cracks.</p>
<p>Bolted joint.</p>	<p>Discolouration of bolted joints, marks from micro-movements (no dirt or dust around the overlap plates, bolt heads, etc.) or larger scuff marks.</p>	<p>Banging/clicking sounds while driving due to loose or missing bolts.</p>

Inspection method	Requirements, wear limits, etc.	 <b>Instructions for rectification</b>
<p>No deformation or cracks are allowed. Deviation from theoretical surface/shape greater than the specified dimensions is considered to be a deformation.</p> <p>Check whether there are any welds or warping.</p> <p>Check regularly or if you suspect any abnormal stress may have affected the drawbar that there is no deformation or cracking.</p>	<p>No deformation or cracks are allowed. Deviation from the theoretical surface/shape greater than the specified dimensions is considered to be a deformation.</p> <p>Check whether there are any welds or warping.</p> <p>Check regularly or if you suspect any abnormal stress may have affected that the drawbar, that there is no distortion or cracking.</p> <p>Critical areas =  Max. deviation/length 5 mm/1000 mm 3 mm/150 mm</p> 	<p> In the event of cracking, stop driving and immediately visit a workshop, replace damaged parts.</p> <p> In the event of deformation, warping or welds, visit the workshop and replace the damaged parts.</p>
<p>Be aware of rust around bolt heads as well as holes where there have previously been bolts.</p> <p>Check to see if there has been any movement in the bolted joints.</p> <p>Check whether any rotation occurs when tightened to the prescribed tightening torque according to the table (see section Drawbars, General information) for M14 type 8.8.</p> 	<p>No movement is allowed and there should be no rotation when test tightened to the prescribed torque.</p>	<p> In the event of any movement or insufficient tightening torque, visit a workshop, disassemble and inspect the parts.</p> <p> If there are any damaged parts, these must be replaced.</p> <p>When the components have been dismantled, they must be re-tightened after driving 2,500 km.</p> <p>Examples of damage:</p> <ul style="list-style-type: none"> <li>- Deformed holes</li> <li>- Damaged threads</li> <li>- Cut marks on bolts</li> <li>- Fretting damage</li> </ul>

Checkpoint	Symptom	Fault
<p>Complete drawbar.</p>	<p>The surface treatment is flaking/chipped. Rusty water flows out from cavities/partially closed cavities. Loose rust flakes/"soft" material/porosity in the base metal.</p>	<p>"Pitting" of corrosion-discoloured parts. Pitting = rust flakes that are loose or able to be knocked loose from the base material and/or porosity that goes down into the base material.</p>

### Inspection method

Check regularly that there is no rust damage such as "pitting" and "surface rust". Take particular note of cavities and partially enclosed areas, as indicated by the arrows.

Make sure that no sand or dirt has accumulated inside the long bolted profiles.

Reddish brown discolouration on the rear and intermediate parts etc. may be signs of corrosion, the "rust water" that has run out from the cavities.

### Requirements, wear limits, etc.

"Pitting" should not occur; particular attention should be paid to the inside of cavities and partially enclosed areas.

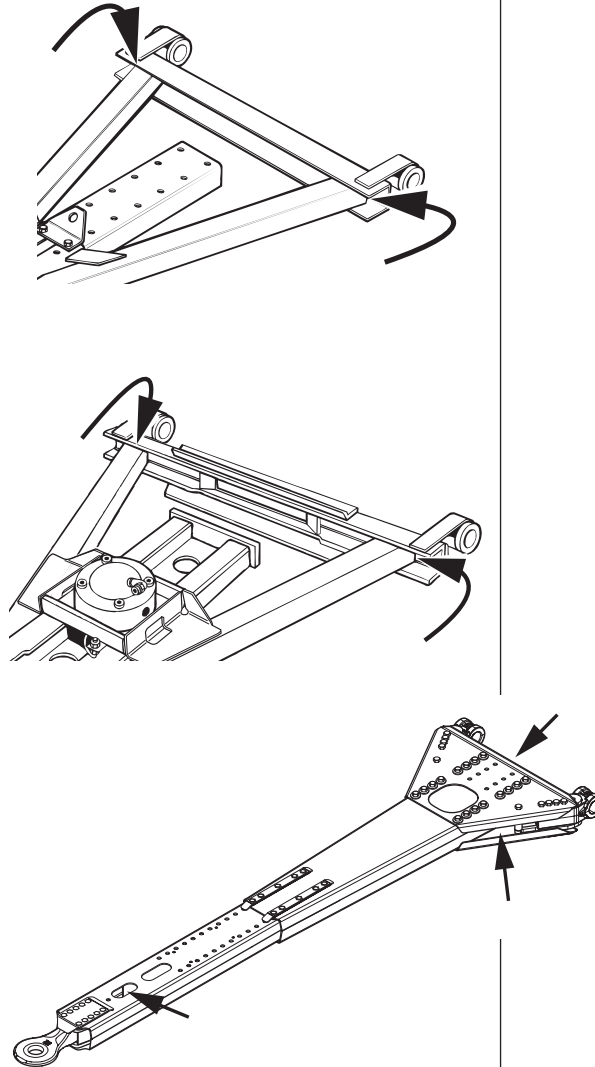

### Instructions for rectification

- 
- 
- ③ Rinse the cavities free of sand and dirt.  
In the event of pitting, stop driving and immediately visit a workshop, replace damaged parts.  
No welding is permitted.  
When the components have been dismantled, they must be re-tightened after driving 2,500 km.

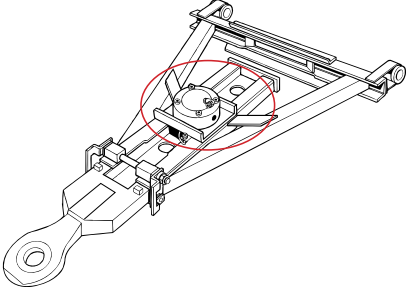
Checkpoint	Symptom	Fault
Air cylinder.	The air tanks are emptied while parked. Leaking sounds.	Automatic drawbar air cylinder leaks.
Air cylinder/bolt/bolt hole.  	Cannot be locked. The front slider slides between its extreme positions.	No locking due to damage/deformation to air cylinder/bolt/bolt hole.
Air cylinder/bolt/bolt hole/ bushings.	Play, noise, jolting between vehicle and trailer when driving on an uneven road.	Rattling from the lifting cylinder/bolt/bushings due to play and wear.

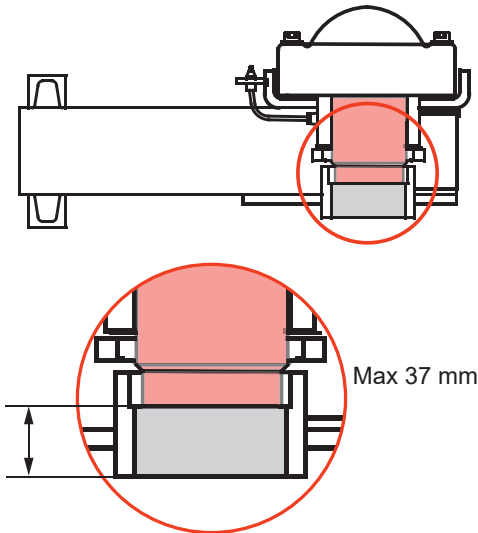
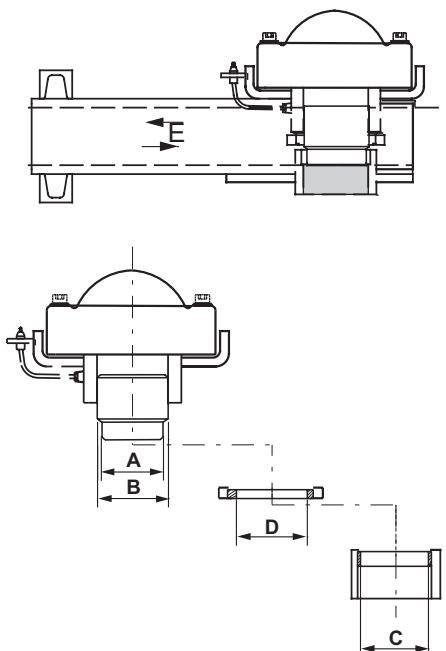

Inspection method	Requirements, wear limits, etc.	 <b>Instructions for rectification</b>
<p>Check pressure drop over time and listen.</p>	<p>No leakage is permitted, 0 NI/h.</p>	<p>① ② ③</p> <p>② Visit a workshop for repairs.</p>
<p>Check that the locking pin moves freely and goes down to its end position. Applies to all installation lengths. Check the locking function and measure check dimension H.</p>	<p>Check dimensions = max. 37 mm from underside of bushing to bolt.</p> 	<p>③ The lock bolt does not achieve the indicated position, stop driving and immediately visit a workshop, replace damaged parts.</p>
<p>Measure maximum play longitudinally between the front and rear sliders, dimension E. Check the dimensions in the diagram.</p> 	<p>5 mm is the maximum permissible play longitudinally between the front and rear sliders.</p> <p>Lock bolt, top                    A: min. 72.5 mm  Lock bolt, middle                B: min. 78.5 mm  Maintenance bushing            C: max. 75 mm  Bushings, front slider          D: max. 81.5 mm</p>	<p>① Contact workshop, change parts that do not meet the requirements for maintaining safety and comfort.</p>

Checkpoint	Symptom	Fault
Adjustment mechanism, wear plates at the sides.	Winding trailer and front slider sometimes difficult to lock in a specific position.	Lateral play between the front and rear sliders due to wear/neglected adjustment.
Adjust mechanism, vertical wear plates.	The mechanism is difficult to open and/or close, especially in the longest positions. The drawbar is makes noise/rattles if there are any bumps in the road.	Play vertically between the front and rear sliders due to wear/neglected adjustment.
Longitudinal stop on the front slider.	Difficult to lock the drawbar in its longest position.	Rear stop on front slider deformed.

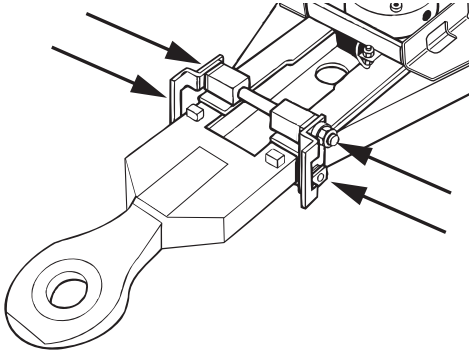
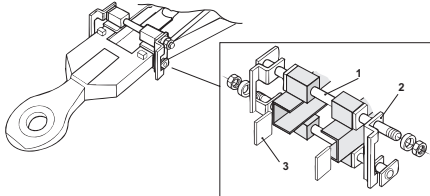
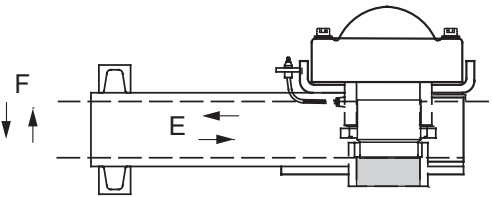
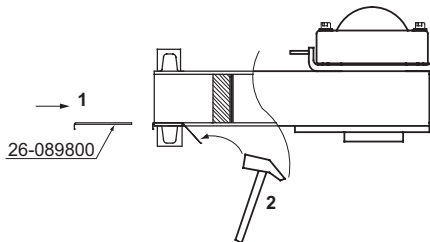
Inspection method	Requirements, wear limits, etc.	 <b>Instructions for rectification</b>
<p>Check lateral play between front and rear sliders.</p>	<p>The play should not exceed 0.5–1 mm to ensure trailer stability.</p> 	<p><b>1</b> Contact a workshop for adjustment; see picture. Re-tightening should be performed regularly. When driving in the same position for a prolonged period, the adjusting bolts should be tightened to reduce wear and any play.</p> 
<p>Check whether the air cylinder lifts the mechanism bolt if a person lifts or presses the front part of the rear part while the valve is in the position for opening and the drawbar is connected to a vehicle. Check in the same way whether the air cylinder can press the bolt down when the hole in the front slider is in the correct position.</p>	<p>The locking bolt must assume the correct position regardless of how you lift or push the rear part. Vertical play "F" between the front and rear sliders should not exceed 1 mm; see picture.</p> 	<p><b>1</b> Contact workshop, minimise play using wear plates no. 26-089800. Can be mounted both at the top and bottom, and if necessary with more than one wear plate at each location, see diagram.</p> 
<p>Pull out the drawbar to the position that the rear stop permits and lock the front slider using the locking bolt.</p>	<p>It must be possible for the bolt to enter the front slider's rear hole when the drawbar is fully extended.</p>	<p><b>2</b> If the stop has been deformed, you are permitted to hot-straighten or weld a new stop.</p>

## General information on drawbar eyes

Checkpoint	Symptom	Fault
Bolted joint.	Noise, rattling, clicking, scuff marks, absence of dirt/dust around bolt heads and overlap joints, discolouration of rust-coloured water.	Loose or missing bolts/nuts.
Bushing/wear ring.	Connection and/or disconnection problems. Bushing/wear ring axially displaced. The wear ring is not level with the eye.	Loose or damaged bushing/wear ring.
Bushing/wear ring/drawbar eye.	The trailer "jolts" if the road is uneven. Rattling/noise.	Worn bushing/wear ring/drawbar eye.
Bushing/wear ring/drawbar eye.	Be aware of whether the coupling triggers during connection and disconnection, and of noise when driving. Check the height dimension of the eye on the most worn surface.	Drawbar eye/wear ring vertically very worn or pitting in the supporting surfaces.

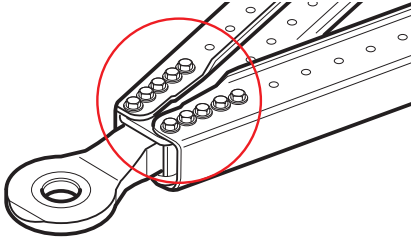
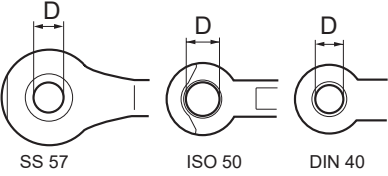
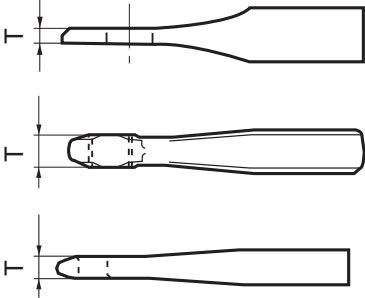
Inspection method	Requirements, wear limits, etc.	 <b>Instructions for rectification</b> ①②③										
<p>Be aware of popping/clicking sounds or jerks when driving with a trailer. Be aware of rust around bolt heads as well as holes where there have previously been bolts. Check to see whether there has been any movement in the bolted joint. Check whether there is any rotation when test-tightened to the prescribed tightening torque.</p>	<p>No movement between parts is permitted and there should be no rotation during test tightening to the prescribed tightening torque. All bolts must be fitted.</p> 	<p>③ In the event of movement in the bolted joint, stop driving and visit a workshop immediately. Dismantle/check constituent parts and replace any that are damaged.</p> <p>② If there is too low a tightening torque, visit a workshop. Dismantle/check constituent parts and replace any that are damaged. When the components have been dismantled, they must be re-tightened after driving 2,500 km.</p>										
<p>Check whether the drawbar is difficult to connect or disconnect. Check whether the bushing in the eye is loose by tapping lightly with a hammer on the bushing/wear ring.</p>	<p>The bushing must be secure and in the correct position. There should be no movement.</p>	<p>② In the event of a loose wear ring/bushing, visit the workshop to replace the damaged material</p>										
<p>Measure the bushing's max. diameter D.</p> 	<p>The wear limits for the bushing/wear ring in the drawbar eye are indicated in table.</p> <table border="1" data-bbox="635 1070 995 1227"> <thead> <tr> <th>Type</th> <th>Max. D (mm)</th> </tr> </thead> <tbody> <tr> <td>SS 57</td> <td>59.5</td> </tr> <tr> <td>ISO 50</td> <td>52</td> </tr> <tr> <td>DIN 40</td> <td>42</td> </tr> </tbody> </table>	Type	Max. D (mm)	SS 57	59.5	ISO 50	52	DIN 40	42	<p>② Replace the wear ring/bushing no later than when max. D has been reached.</p> <p><b>NB:</b> Welding is prohibited.</p>		
Type	Max. D (mm)											
SS 57	59.5											
ISO 50	52											
DIN 40	42											
<p>Check whether the coupling triggers during connection and disconnection, and whether rattling and noise is heard during driving. Measure the eye's height dimension T on the most worn surface.</p> 	<p>Each drawbar eye's minimum dimension must be achieved.</p> <table border="1" data-bbox="616 1361 976 1556"> <thead> <tr> <th>Type</th> <th>Min. T (mm)</th> </tr> </thead> <tbody> <tr> <td>SS 57</td> <td>19</td> </tr> <tr> <td>NATO</td> <td>37</td> </tr> <tr> <td>ISO 50</td> <td>42.5</td> </tr> <tr> <td>DIN 40</td> <td>28</td> </tr> </tbody> </table>	Type	Min. T (mm)	SS 57	19	NATO	37	ISO 50	42.5	DIN 40	28	<p>② Replace the drawbar eye if it is thinner than specified dimension T.</p> <p><b>NB:</b> Welding is prohibited</p>
Type	Min. T (mm)											
SS 57	19											
NATO	37											
ISO 50	42.5											
DIN 40	28											

## General information on drawbar eyes

Checkpoint	Symptom	Fault
The drawbar eye's outer geometry.	Difficult to connect.	Worn down outer radius.
The drawbar eye's outer geometry.	<p>Marks from jackknifing on endplates, drawbar, etc.</p> <p>Marks from the tipper body, top of the drawbar.</p> <p>The drawbar eye is not sitting symmetrically in the drawbar.</p>	Bent drawbar eye due to overloading.
The drawbar eye and its attachment.	<p>Rust residue around a possible crack.</p> <p>Cracked paint.</p> <p>Other damage in connection with jackknifing.</p>	Cracks in the drawbar eye and in connection with the drawbar eye attachment in the front slider.

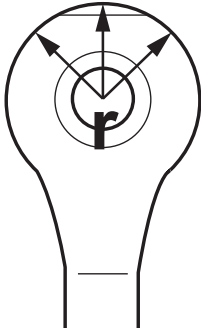
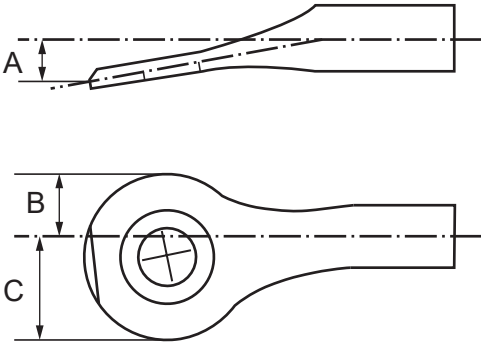
Inspection method	Requirements, wear limits, etc.	 <b>Instructions for rectification</b>								
<p>Measure the outer radius as shown in the figure.</p> 	<p>Minimum radius R according to the table.</p> <table border="1" data-bbox="611 322 1007 506"> <thead> <tr> <th>Type</th> <th>Min. radius (mm)</th> </tr> </thead> <tbody> <tr> <td>SS 57</td> <td>90</td> </tr> <tr> <td>ISO 50</td> <td>55</td> </tr> <tr> <td>DIN 40</td> <td>48</td> </tr> </tbody> </table>	Type	Min. radius (mm)	SS 57	90	ISO 50	55	DIN 40	48	<p><b>1</b> Replace the drawbar eye if the measured R is less than the specified dimension in the table "Min. Radius".</p> <p><b>NB:</b> Welding is prohibited.</p>
Type	Min. radius (mm)									
SS 57	90									
ISO 50	55									
DIN 40	48									
<p>Check whether the drawbar eye is bent vertically and/or laterally. Check that the welding and bolted joints are free of cracks. Check that the flange/shank of the eye are free of cracks. Measure dimensions A and C and D on the drawbar eye/drawbar's centre line; see picture.</p>	<p>Assessment, no cracks are permitted. Note: do not mix up the angled drawbar eye for the Multi XF or Optimal drawbar with the one bent vertically.</p> <p>A ≤ 2 mm B, C ≤ 2 mm</p> 	<p><b>3</b> In the event of a bent/overloaded eye, stop driving and immediately visit a workshop, replace damaged parts. If the drawbar eyes are bolted, the bolted joint must be checked and the bolts replaced. When the components have been dismantled, they must be re-tightened after driving 2,500 km.</p> <p><b>NB!</b> Warping a drawbar eye is strictly forbidden.</p>								
<p>Also check for any cracks in the geometry adjacent to the drawbar eye, both before and after cleaning. If you suspect that there is a crack, investigate using liquid penetrant.</p>	<p>No cracks are permitted.</p>	<p><b>3</b> In the event of cracking, stop driving and immediately visit a workshop, replace damaged parts.</p> <p><b>NB:</b> Welding is prohibited.</p>								

## Screwed flange eyes 50/57

Checkpoint	Symptom	Fault
Contact surfaces flange/ mounting plate, bolts and Nord- Lock washers.	Some movement between the flange and the drawbar's mounting plate. Marks from jackknifing.	Loose or missing bolts due to overload.
Contact surfaces flange/ mounting plate, bolts and Nord-Lock washers.	Regular re-tightening required. Some bolts worn out/defective. Absence of dirt/dust in the bridge between the flange and mounting plate, and discolouration of rust-coloured water may occur.	Loose or missing bolts due to mounting plate that is not level.

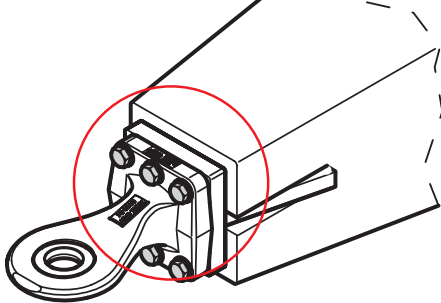
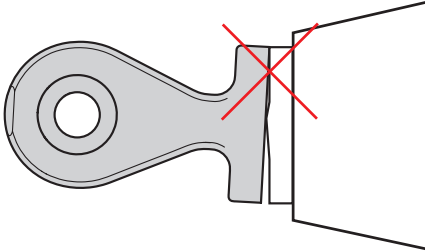

Inspection method	Requirements, wear limits, etc.	 <b>Instructions for rectification</b> ①②③
<p>Check to see if there has been any movement in the bolted joints.            Check whether any rotation occurs when test-tightened to the prescribed tightening torque, 390 Nm for M16 type 12.9 with Nord-Lock washers fitted.            Check whether there are marks from jackknifing.</p>	<p>No movement is permitted and there should be no rotation during test-tightening to the prescribed tightening torque. All bolts must be fitted.</p> 	<p>③ In the event of movement in the bolted joint, stop driving and immediately visit a workshop, dismantle/check constituent parts and replace any damaged components.</p> <p>② In the event of an insufficient tightening torque, visit a workshop, dismantle/check the constituent parts and replace damaged components.            New bolts and North Lock Washers should always be fitted when the eye has been dismantled.            When the components have been dismantled, they must be re-tightened after driving 2,500 km.</p>
<p>Check whether there has been any movement in the bolted joint and/or between the flange and the mounting plate.            Check whether any rotation occurs when test-tightened to the prescribed tightening torque, 390 Nm for M16 type 12.9 with Nord-Lock washers fitted.            Check that the drawbar eye's flange surface sits firmly against the drawbar's connection surface.</p>	<p>The bolted joint must not lose its tension. The connection surfaces of the flange drawbar eye and the drawbar's mounting plate must lie completely flush against each other without gaps.</p> 	<p>③ In the event of repeated wear and tear in bolted joints resulting in insufficient tightening torques, visit a workshop, dismantle/check the components and replace any that are damaged.            The drawbar's connection surfaces must be levelled if required, flatness requirement = 0.5. New bolts and Nord-Lock washers should always be fitted when the drawbar eye has been dismantled.            When the flange eye has been dismantled, it must be re-tightened after driving 2,500 km.</p>

**Drawbar eyes 40/50/57/Nato76 fitted with castellated nuts/Clamped drawbar eye**

<b>Checkpoint</b>	<b>Symptom</b>	<b>Fault</b>
<p><b>Drawbar eyes 40/50/57/Nato76 fitted with castellated nuts</b></p> <p>Contact surfaces drawbar eye/sleeve/castellated nut.</p>	<p>Noise, rattling, clicking, scuff marks, absence of dirt/dust in the transition section between the sleeve and drawbar eye, and discolouration of rust-coloured water is in evidence.</p>	<p>Play between sleeve, drawbar eye and castellated nut.</p>
<p><b>Clamped drawbar eye</b></p> <p>Drawbar eye, mounting plate, clamp, bolted joint.</p>	<p>Regular re-tightening required. Some movement between constituent parts. Absence of dust/dirt around bolts/drawbar eye/clamp or between clamp and attachment plate/drawbar eye.</p>	<p>Regular re-tightening required. Some movement between constituent parts. Absence of dust/dirt around bolts/drawbar eye/clamp or between clamp and attachment plate/drawbar eye.</p>

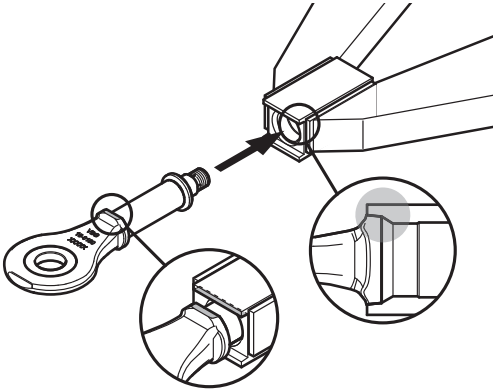
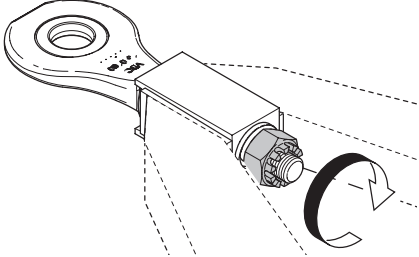
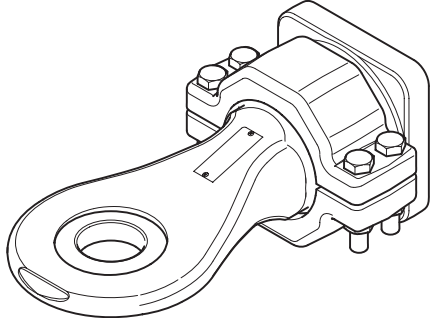
Inspection method	Requirements, wear limits, etc.	 <b>Instructions for rectification</b>
<p>Be aware of banging/clicking sounds or jolts when driving with a trailer. Also be aware of any rust forming around the castellated nut and around the contact surfaces between the drawbar eye and sleeve.</p> <p>Check carefully that there is no movement in the same contact area.</p>	<p>No movement is permitted and there must be no rotation of the castellated nut and/or the drawbar eye in the sleeve.</p> 	<p>① ② ③</p> <p>② In the event of movement or play, stop driving and immediately visit a workshop to replace damaged parts. When the parts have been dismantled, re-tightening must take place after driving 2,500 km and a new cotter must be fitted.</p> 
<p>Check to see if there has been any movement in the bolted joints.</p> <p>Check whether any rotation occurs when test-tightened to the prescribed tightening torque, 180 Nm for M16 type 8.8 with Nylock washers fitted.</p>	<p>No movement is allowed and there should be no rotation when test tightened to the prescribed torque.</p> 	<p>③ In the event of movement in the bolted joint, stop driving and immediately visit a workshop, dismantle/check constituent parts and replace any damaged components.</p> <p>② In the event of an insufficient tightening torque, visit a workshop, dismantle/check the constituent parts and replace damaged components. When the clamped drawbar eye has been dismantled, it must be re-tightened after driving 2,500 km.</p>



**The strong connection**

 MEMBER OF VBG GROUP

[www.vbg.eu](http://www.vbg.eu)

---